

MULTIframe™

Setzen Sie auf maximale FLEXIBILITÄT: Die hochwertigen MULTIframe™ - Aluminiumprofile sind in jeder Größe erhältlich, einfach zu montieren und in kürzester Zeit lieferbar.

Überzeugen Sie durch beste LICHTQUALITÄT: Innovative OSRAM LEDs garantieren eine gleichmäßige brillante Ausleuchtung über die gesamte Fläche. Durch den geringen Energieverbrauch und die wartungsfreie Technik sind MULTIframe™ - Rahmen ein zuverlässiges Produkt für Ihre Anwendungen über viele Jahre hinweg.

Verlassen Sie sich auf bestes KUNDENSERVICE: MULTIframe™ bietet für jede Herausforderung die richtige Lösung. Die hochwertigen Leuchtmittel arbeiten ausfallsfrei und unterliegen - wie auch die Rahmen - einer dreijährigen Garantie.

Focus on maximum ADAPTABILITY: high-quality MULTIframe™ aluminium profiles are available in any size, easy to install and are readily available to ship quickly.

Persuade with the best LIGHTING QUALITY: Innovative OSRAM LEDs guarantee a uniform and brilliant illumination for the entire area. Thanks to the low energy use and maintenance-free technology, MULTIframe™ frames will be a reliable product for applications for years to come.

Depend on the best CUSTOMER SERVICE: MULTIframe™ offers the right solution for every challenge. These high-quality luminaires and their frames function reliably and come with a 3-year guarantee.

Überzeugungskraft SINNESREIZ Ökofaktor UBERZEUGUNGSKRAFT Impulsgeber
Blickfang Aufmerksamkeit IMPULSGEBER Blickfang Aufmerksamkeit
SINNESREIZ Ökofaktor

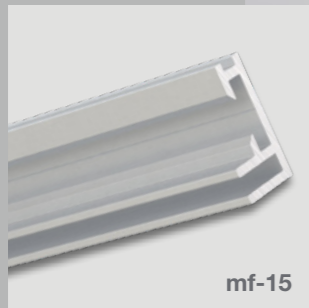

mf-15

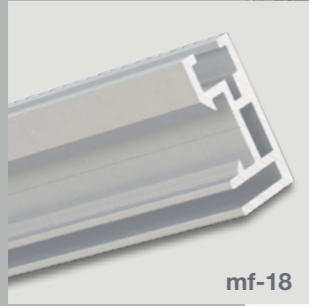

mf-18

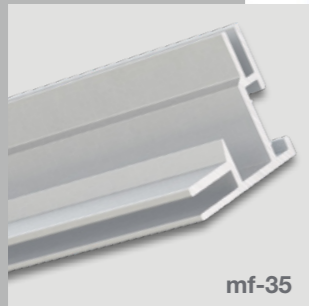

mf-35

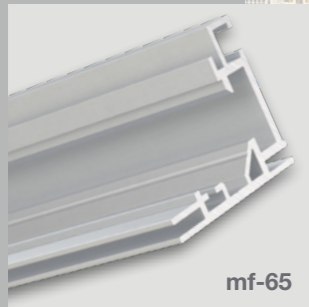

mf-65



mf-160BL

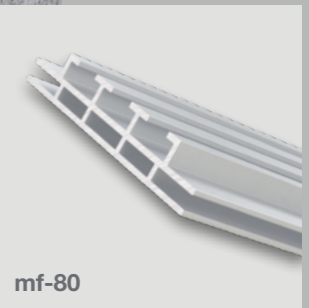

mf-80

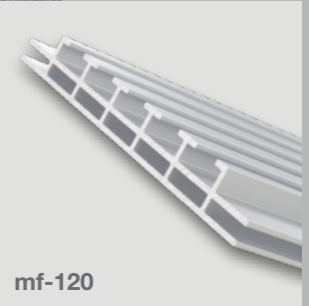

mf-120

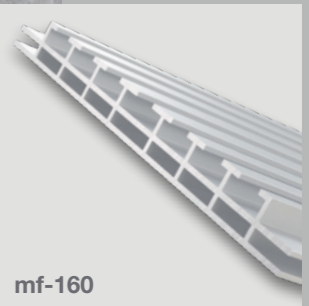

mf-160



mf-120CL



mt-out



ASIG

BACKLOAD

BATTERY

MULTITOWER

SIDE LIGHT

LEDUP

SIDE LIGHT

SUPER SLIM

BACKLOAD

LEDUP

BASIC

SUPER SLIM

MULTITOWER

BATTERY

BASIC

– Rahmenprofile in diversen Bautiefen erhältlich

- Material - silber eloxierte Aluminiumprofile mit Stahlverbindern
- Stoffdruckverspannung mittels Gummilippen
- einfache Montage und schneller Motivwechsel
- Profile in RAL-Farben (Pulverbeschichtung) auf Anfrage erhältlich
- Ersatzteile erhältlich

– frame profiles available in various widths

- material - silver anodized aluminium profiles with steel connectors
- fabric print attaches to the frame with silicon edging
- easy to assemble and graphics change easily
- profiles in RAL- colours (powder coating) available upon request
- spare parts available

■ mf-80

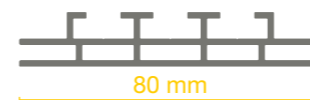

■ mf-120



■ mf-120CL



■ mf-160

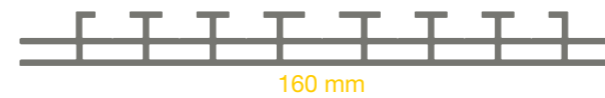

■ mf-160BL

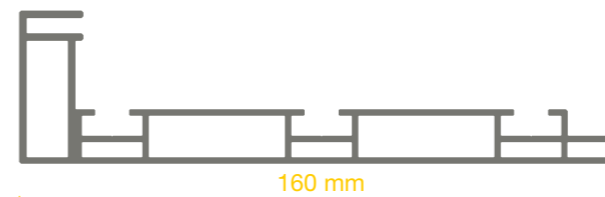

■ mf-18



■ mf-35

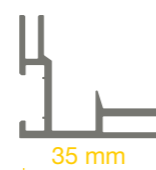

■ mf-65

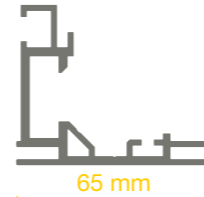

Deckenabhängung vertikal /
suspension vertical



Wand- und Deckenmontage /
wall and ceiling mounting



Stellwand freistehend /
free standing display

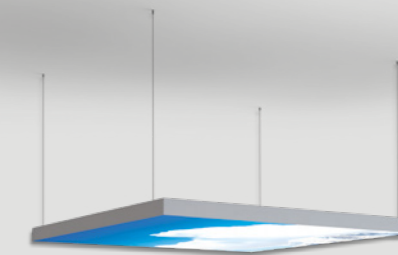

Deckenabhängung horizontal /
suspension horizontal



Wand- und Deckenmontage - Sonderform /
wall and ceiling mounting - special



Deckenring / ceiling ring

SUPER SLIM



multi frame - super slim

– dünnster Vollflächen LED Rahmen der Welt

- Rahmenprofil in 2 Bautiefen erhältlich - 35 und 65 mm
- vollflächige, homogene Ausleuchtung dank qualitativ hochwertiger LED Technik mit speziell angepasster Linsenform
- energiesparend durch moderne LED Technik
- Leuchtkraft ca. 45 watt/m², 7000 lm, 1600 cd/m², Farbtemperatur 6500 Kelvin
- Sonderformate möglich
- Wandmontage und Montage in Laibung möglich

– *thinnest full-face LED frame in the world*

- *frame profile available in 2 depths - 35 and 65 mm*
- *full-area, homogeneous illumination thanks to high quality LED technology with specially adapted lens shape*
- *modern LED technology - energy saving*
- *luminance approx. 45 watt/m², 7000 lm, 1600 cd/m², colour temperature 6500 kelvin*
- *custom sizes available*
- *inset wall mounting optional*

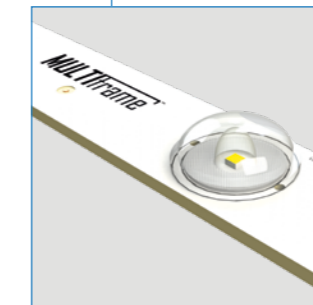
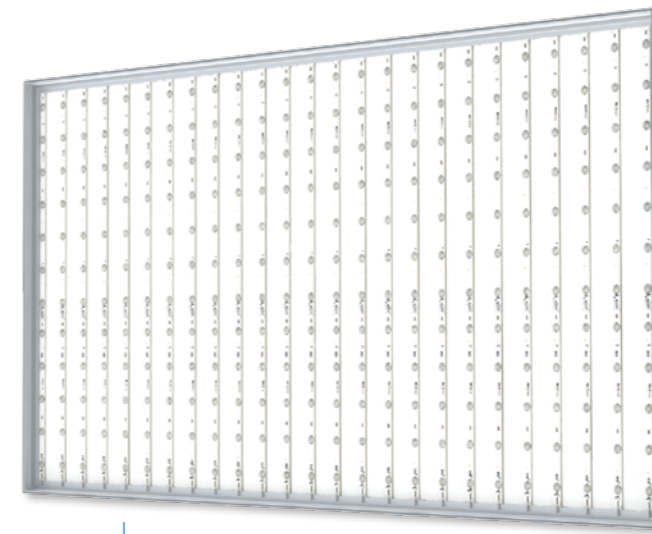

■ Wandmontage / wall mounting

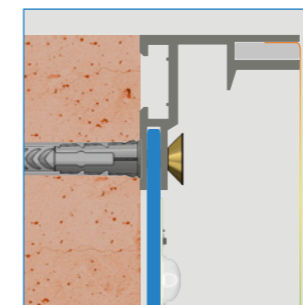

■ Laibung / inset into wall

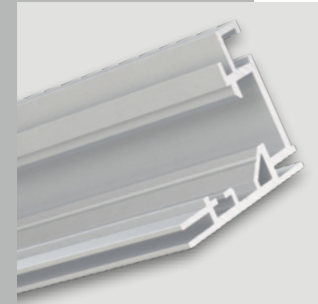
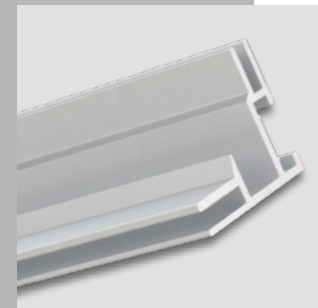
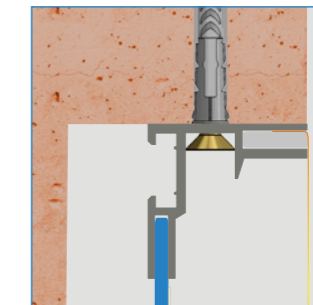

Profildesign mf-35 / profile design mf-35

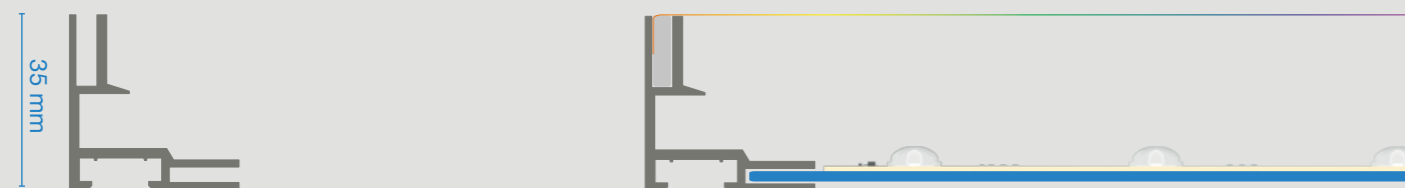

Profildesign mf-65 / profile design mf-65

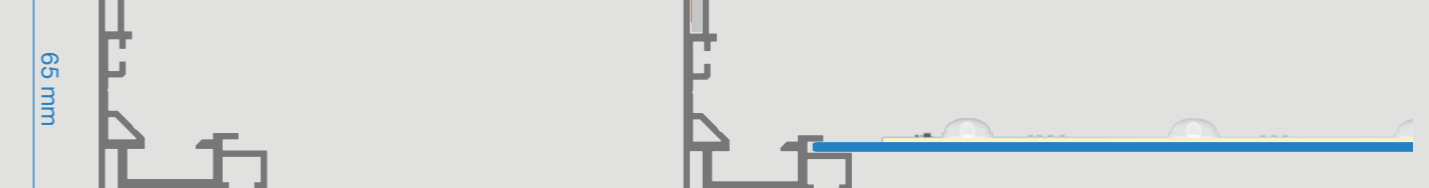

Zubehör /
accessories

Eckverbinder /
corner connector

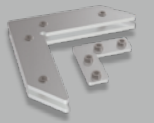

gerader Verbinder /
straight connector

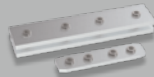

LED Module /
LED lights

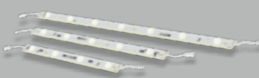

Dimmer / dimmer



Profile in diversen
Farben erhältlich /
profiles in various
colours available



SIDE LIGHT



multi frame - side light

– großformatige ein- & doppelseitige LED Leuchtkästen

- Rahmenprofil in 3 Bautiefen erhältlich - 80 mm, 120 mm und 160 mm
- Beleuchtung mittels seitlicher LED Einstrahlung
- energiesparend durch moderne LED Technik
- Leuchtkraft ca. 2 Watt/LED, 140 lm/Watt, 400 - 750 cd, 6500 Kelvin
- maximale Ausleuchtung bis 300 cm - Baulänge beliebig
- Netzteile im Rahmen verbaut
- auf Anfrage dimmbar

– single & double sided large format LED light boxes

- frame profile available in 3 dimensions - 80 mm, 120 mm and 160 mm
- LED side illumination
- modern LED technology - energy saving
- luminance approx. 2 watt/LED, 140 lm/watt, 400 - 750 cd, 6500 kelvin
- 2 sides illumination - up to 300 cm wide - length unlimited
- transformers built into the frames
- dimmable LEDs upon request

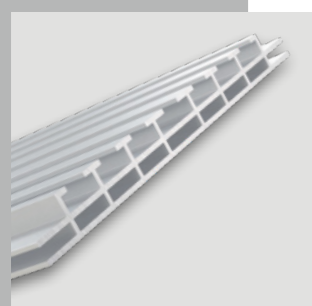
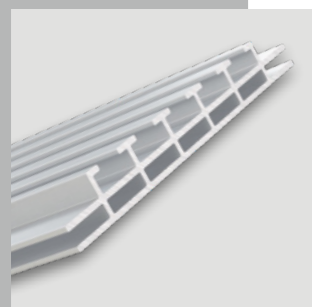
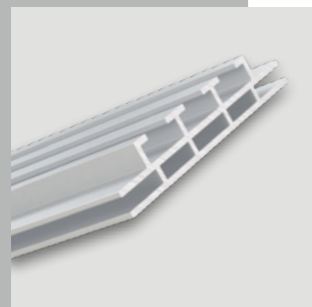
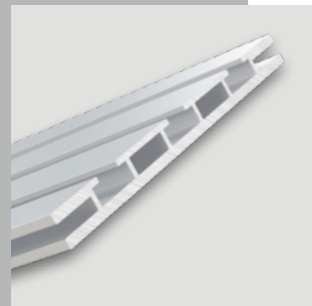

Systemdetails / system details

beidseitige, homogene Ausleuchtung dank qualitativ hochwertiger OSRAM LED Technik mit speziell angepasster Linsenform

double sided illumination - even lighting using OSRAM LED technique including a specially adapted lens

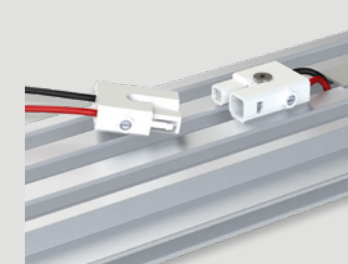
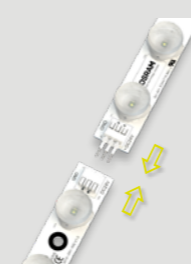

mf-SL-120CL

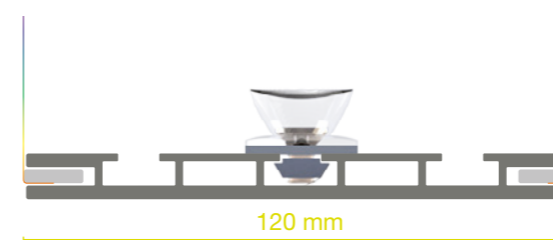

mf-SL-80

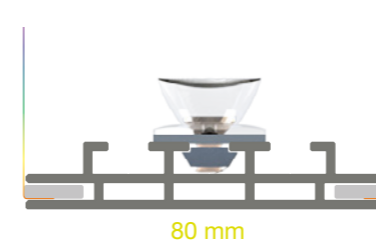

mf-SL-120

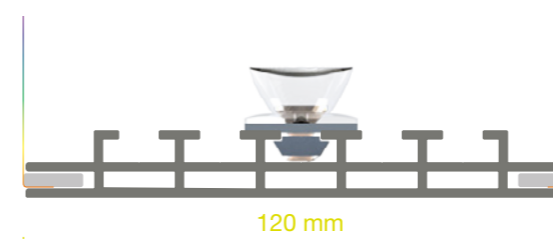

mf-SL-160

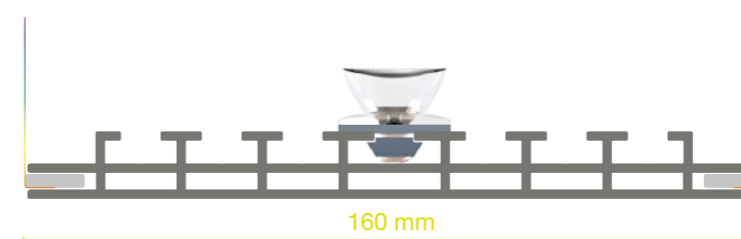

Zubehör / accessories

Eckverbinder 90° / corner connector 90°



Stellfuß - optional mit Rollen / base - optional with casters



Wandhalterung / wall fixture



Deckenabhängung / ceiling suspension



LED Module / LED lights



Profile in diversen Farben erhältlich / profiles in various colours available



BACKLOAD

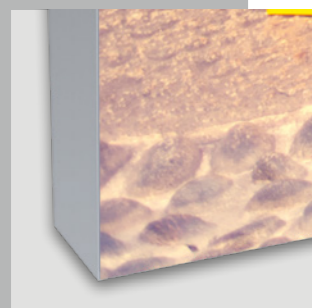
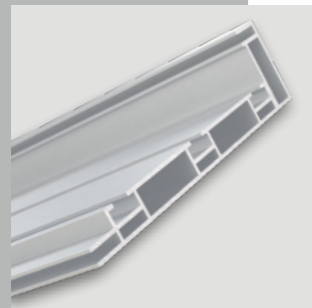

multi frame - back load

– bestens geeignet für Fixmontage im Schaufenster

- Motivwechsel der beiden Stoffdrucke von einer Seite (Rückseite) möglich
- maximale Ausleuchtung bis 300 cm - Baulänge beliebig
- beidseitige, homogene Ausleuchtung dank qualitativ hochwertiger OSRAM LED Technik mit speziell angepasster Linsenform
- Netzteile im Rahmen verbaut
- auf Anfrage dimmbar
- verwindungssteife Konstruktion

– best for fixed mounting in a shop window

- both graphics change from one side (back)
- 2 sides illumination - up to 300 cm wide - length unlimited
- even lighting illumination - using OSRAM LED technique including a specially adapted lens
- transformers built into the frames
- dimmable LEDs upon request
- rigid construction

OSRAM
LED Technology included

Profildesign / profile design



BATTERY

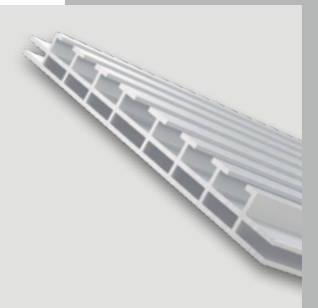

multi frame - battery

– mit Akkubetrieb & Stellfüße

- beleuchteter, oberer Rahmen 80x180 cm / 100x180 cm
unbeleuchteter, unterer Rahmen mit eingebautem Akku 80x40 cm / 100x40 cm
- beidseitige, homogene Ausleuchtung dank qualitativ hochwertiger OSRAM LED Technik mit speziell angepasster Linsenform
- Leuchtkraft ca. 88 Watt
- ca. 4,5 Stunden Leuchtleistung
mit extern wiederaufladbarem 24 Volt Lithium-Ionen Powerpack (15 Ah)
- alternativ für standardmäßigen Stromanschluss verwendbar

– with battery & bases

- illuminated upper frame 80x180 cm and 100x180 cm
non-illuminated lower frame with built-in battery 80x40 cm and 100x40 cm
- double sided illumination - even lighting using OSRAM LED technique including a specially adapted lens
- low power consumption 88 watt
- approx. 4,5 hours illumination
with externally rechargeable 24 volt lithium-ion powerpack (15 Ah)
- useage of standard electricity possible

OSRAM
LED Technology included

Profildesign / profile design

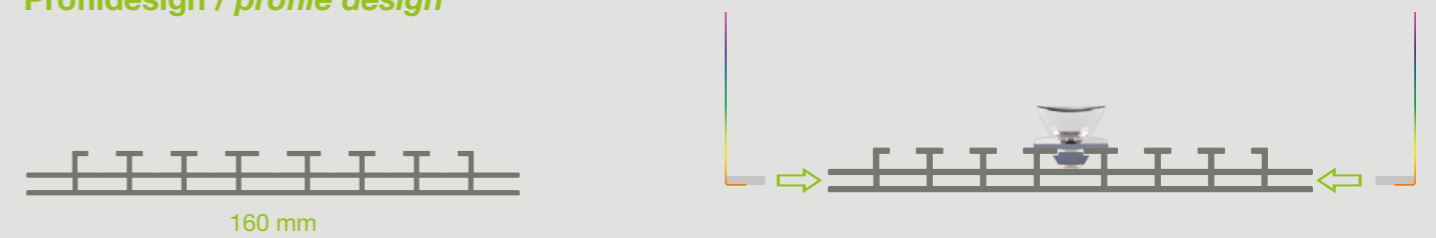

MULTI TOWER

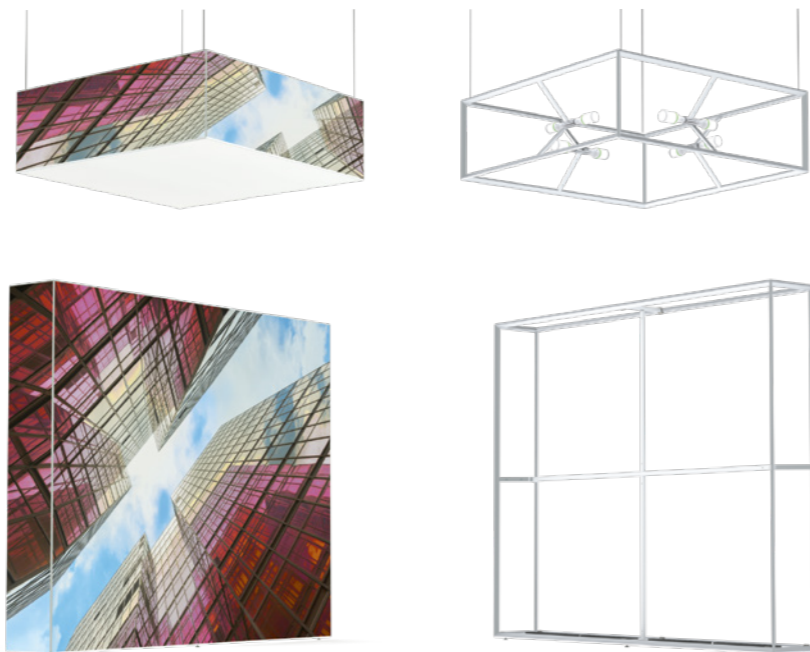

multi tower

– Profile speziell zur Konstruktion von 3D Objekten

- Material - silber eloxierte Aluminiumprofile mit Zinkdruckgussverbindern
- Stoffdruckverspannung mittels Gummilippen
- einfache Montage und schneller Motivwechsel
- energiesparend durch moderne LED Technik
- Profile in RAL-Farben (Pulverbeschichtung) auf Anfrage erhältlich

– profiles specially designed for 3D objects

- material - silver anodized aluminium profiles with zinc die-cast connectors
- fabric print attaches to the frame with silicon edging
- easy to assemble and graphics change easily
- modern LED technology - energy saving
- profiles in RAL-colours (powder coating) available upon request

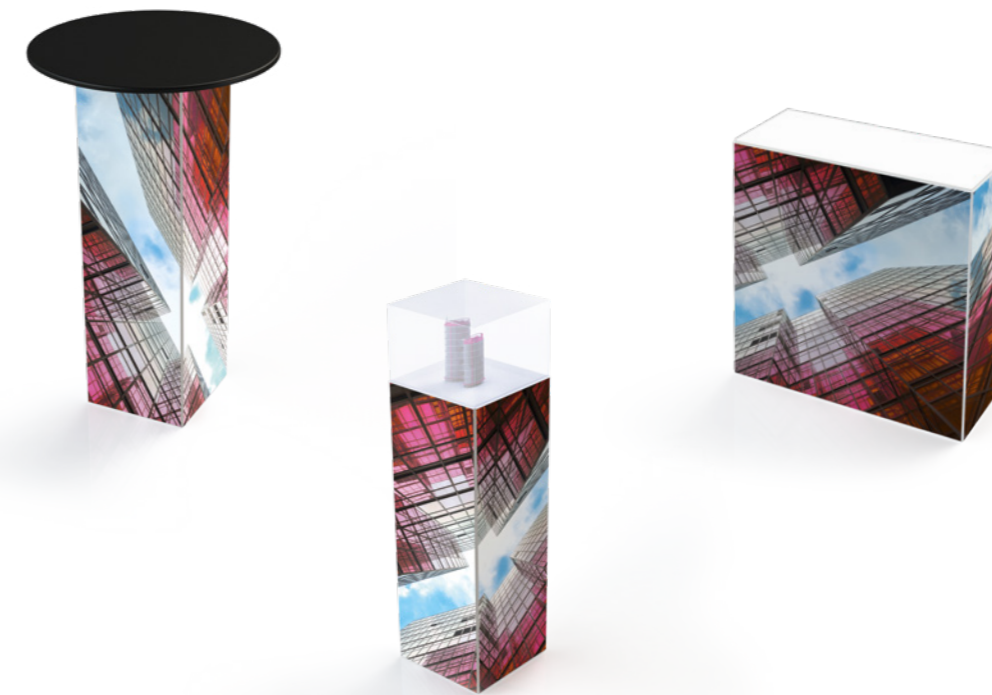

Zubehör / accessories

Stellfuß
höhenverstellbar /
adjustable base



seitliche Einstrahlung /
edge lighting



LED Lampen /
LED lamps

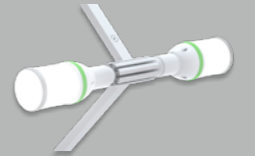

Versteifungselement /
crosses to add stability



gerader Verbinder /
straight connector



Profile in diversen
Farben erhältlich /
profiles in various
colours available



Profildesign mt-out - Außenecke / profile design mt-out - outside corner

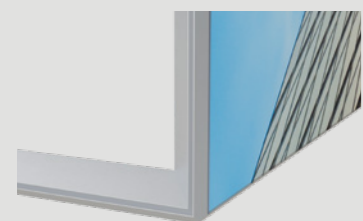

Profildesign mt-in - Innenecke / profile design mt-in - inside corner



